



P/N 52261-06
MODEL 2505ES



Balboa Instruments Incorporated
BALBOA INSTRUMENTS INC.
TUSTIN, CA.







Certified to comply with the limits for a class B computing device pursuant to subpart J of part 15 of the FCC rules

60 HZ

MODEL: DU-2505ES-DCAH

PAT. NO. 4618797

GROUND

			
Ground	Hot	Hot	Neutral

USE COPPER CONDUCTORS ONLY. 6 AWG

240V
40A
60Hz



Balboa Instruments Incorporated
10/16/02

2505ES SYSTEM WIRING DIAGRAM

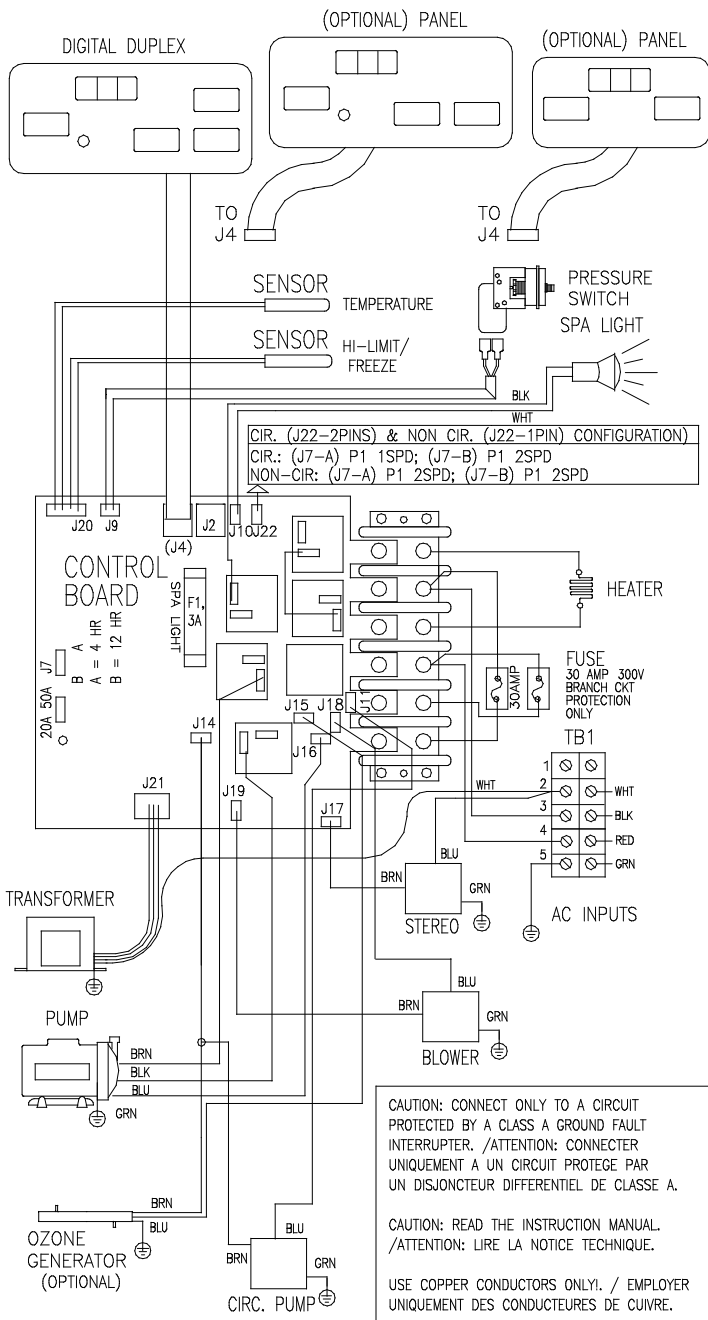

CAUTION: CONNECT ONLY TO A CIRCUIT PROTECTED BY A CLASS A GROUND FAULT INTERRUPTER. /ATTENTION: CONNECTER UNIQUEMENT A UN CIRCUIT PROTEGE PAR UN DISJONCTEUR DIFFERENTIEL DE CLASSE A.

CAUTION: READ THE INSTRUCTION MANUAL. /ATTENTION: LIRE LA NOTICE TECHNIQUE.

USE COPPER CONDUCTORS ONLY!. / EMPLOYER UNIQUEMENT DES CONDUCTEURS DE CUIVRE.

J & J PART#S
PUMP-1 20198
OZONE 20679
SPA LIGHT 20259